



LOADING RAMPS

Tailored loading and unloading solutions



Our Loading Ramps

Our ramps are designed to adapt to the loading and unloading operations, meeting the needs of your vehicle and your industry.



11 UNIQUE RAMP MODELS

Made of high-quality aluminum and designed in Italy, our loading ramps offer modular and customizable solutions designed to ensure safety, durability and optimal performance.

OUR RAMPS

ALL RAMPS HAVE



All of our ramps
are TÜV certified



Approval
not required



100%
Made in Italy



2 years of
warranty

WHY CHOOSE OUR RAMPS

Flexibility:

A complete range of manual ramps for every sector and need;

Quality:

Guaranteed by in-house production processes (welding and CNC machining) that ensure robustness and durability;

Time saving:

The operator can upload and unload independently;

Safety:

Ramps improve working conditions reduce operational risks;

**WITH MORE THAN 100 RESELLERS WORLDWIDE,
OUR SOLUTIONS ARE WHEREVER YOU NEED THEM.**

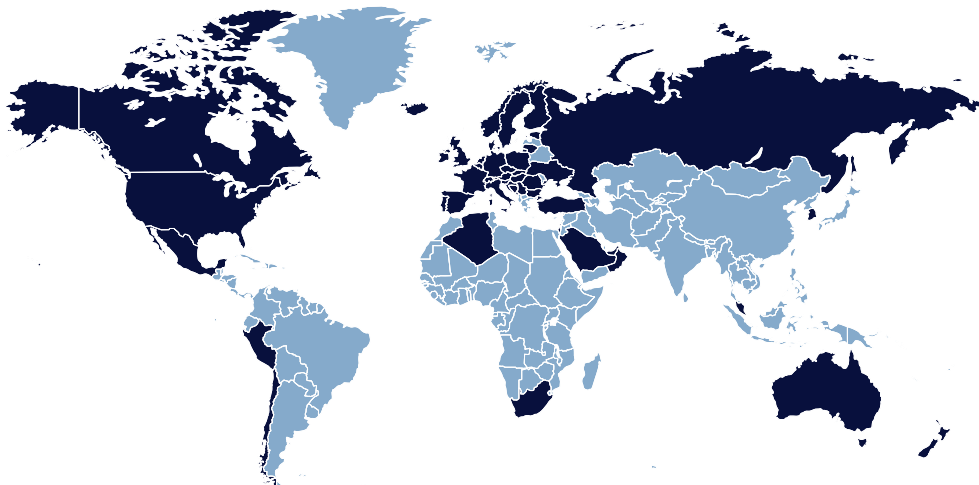

WM PC

DESCRIPTION:

Loading ramp suitable for loads up to 1800 kg for light commercial vehicles. **Over 500 sizes available.**



FEATURES



Capacity:
600kg to 1800kg



Handling:
External and internal rotation



Custom size:
Width 60 to 137.5 cm,
Length 195 to 325 cm

- Almond-shaped aluminum surface non-skid.
- Wheel for easy opening.
- Self-leveling legs.
- Adjustable band that connects with surfaces.

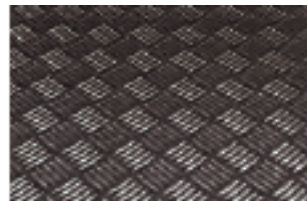

OPENING AND CLOSING:

Patented dual opening/closing system: horizontal for loading/unloading and vertical to clear the cargo area and access to the van. The spring system balances the weight, making the ramp light and safe to handle independently.

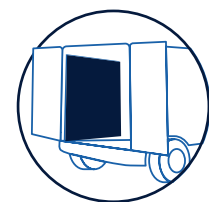
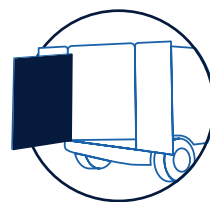
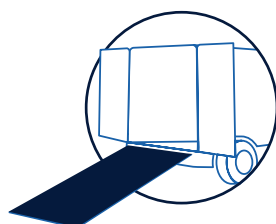
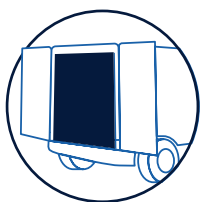

WM PC

EXAMPLES OF POSSIBLE CONFIGURATIONS

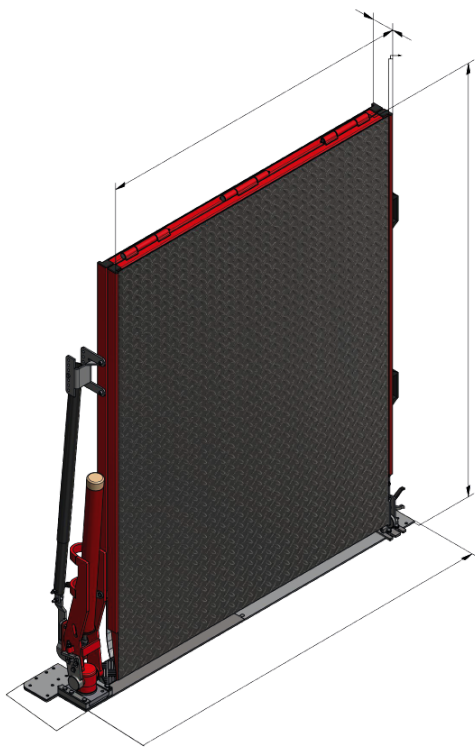

L2 (mm)	A (mm)	L (mm)	H (mm)	P (mm)	P1 (mm)	P2 (mm)	Capac. (Kg)	Peso* (Kg)
900	2200	1165	1215	95	250	8	600	81
950	2500	1215	1365	95	250	8	600	88
1000	3000	1265	1615	95	250	8	1000	106
1000	3250	1265	1740	95	250	8	1500	124
1050	2700	1315	1515	95	250	8	600	96
1100	3000	1365	1615	95	250	8	1500	131
1100	2500	1365	1365	95	250	8	1000	106
1200	2700	1465	1465	95	250	8	1000	117
1200	3250	1465	1740	95	250	8	1500	148
1250	2800	1515	1515	95	250	8	1000	128
1250	3000	1515	1615	95	250	8	1500	145
1300	3000	1565	1615	95	250	8	1000	139
1300	3250	1565	1740	95	250	8	1500	159
1350	3200	1615	1715	95	250	8	1500	160
1350	3250	1615	1740	95	250	8	1800	171

* Weight does not include mounting kit, which depends on the van. (min. 2 kg - max. 7 kg)

WM PC

OPTIONAL



INTERNAL FIXING HOOK

Hook can be used to lock the ramp in a fully rotated position inside the vehicle.



ADDITIONAL KIT - 3RD PIECE

Reduces the angle of inclination for 3-piece folding ramps, ideal for small vehicles. Available for load capacities up to 1,000 kg, with a maximum width of 100 cm and a fixed length of 80 cm.

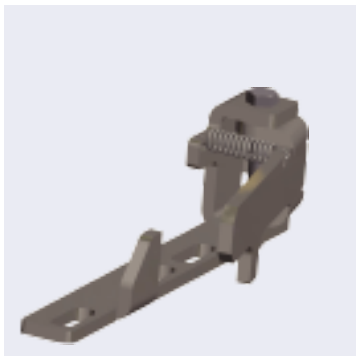

WINDBREAK KIT

The system fixes the ramp in a fully rotated outward position, preventing wind gusts from causing it to move and hit people or property.



REMOVABLE EXTENSION KIT

Removable third piece with wheels, to be integrated to the ramp to extend its length. Suitable for load capacities up to 1,500 kg.

WM PC



WM ME

DESCRIPTION:

Simple and sturdy loading ramp.

Suitable for heavy loads, with load capacity from 600 kg to 1800 kg.



FEATURES



Capacity:

da 600kg a 1800kg



Handling:

Horizontal opening



Custom size:

Width 60 to 137.5 cm,
Length 195 to 325 cm

- Almond-shaped aluminum surface non-skid.
- Wheel for easy opening.
- Self-leveling legs.
- Adjustable band that connects with surfaces.

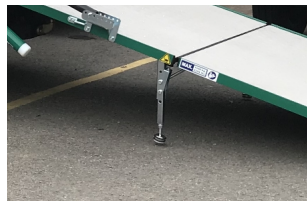
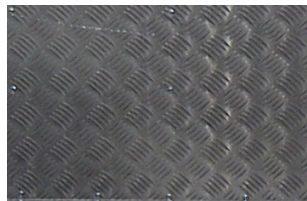

OPENING AND CLOSING:

The ramp consists of two horizontal sections, which open and close with ease. The spring system balances the weight. A version with springs on both sides is available upon request for even easier opening.

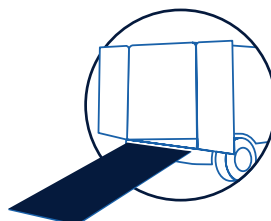
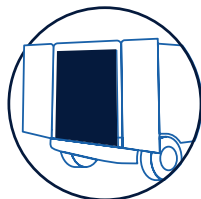
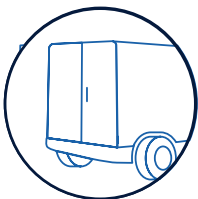

WM ME

EXAMPLES OF POSSIBLE CONFIGURATIONS

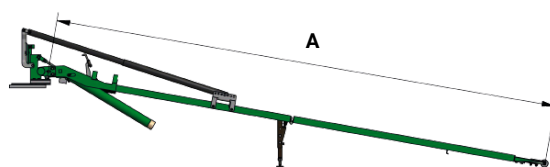
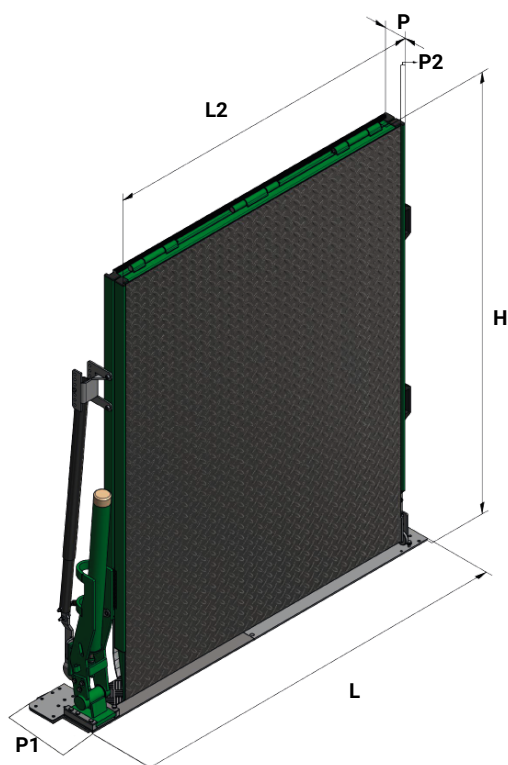

L2 (mm)	A (mm)	L (mm)	H (mm)	P (mm)	P1 (mm)	P2 (mm)	Capac. (Kg)	Peso* (Kg)
900	2200	1165	1215	95	250	8	600	79
950	2500	1215	1365	95	250	8	600	86
1000	3000	1265	1615	95	250	8	1000	104
1000	3250	1265	1740	95	250	8	1500	122
1050	2700	1315	1515	95	250	8	600	94
1100	3000	1365	1615	95	250	8	1500	129
1100	2500	1365	1365	95	250	8	1000	104
1200	2700	1465	1465	95	250	8	1000	115
1200	3250	1465	1740	95	250	8	1500	146
1250	2800	1515	1515	95	250	8	1000	126
1250	3000	1515	1615	95	250	8	1500	143
1300	3000	1565	1615	95	250	8	1000	137
1300	3250	1565	1740	95	250	8	1500	157
1350	3200	1615	1715	95	250	8	1500	158
1350	3250	1615	1740	95	250	8	1800	169

* Il peso non comprende il kit di montaggio, che dipende dal furgone. (min. 2 Kg - max. 7 Kg)

WM ME

OPTIONAL



WHEEL KIT

Designed to facilitate the opening and closing of the ramp, making it easier to move. Also available on request for the left side. Optional wheel to be attached to the end(s).

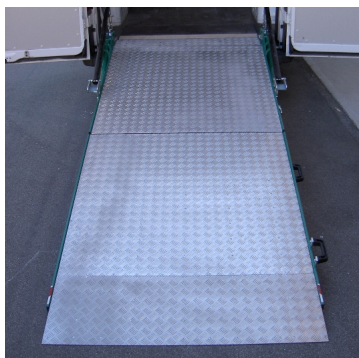

ADDITIONAL KIT - 3RD PIECE

Reduces the angle of inclination for 3-piece folding ramps, ideal for small vehicles. Available for load capacities up to 1,000 kg, with a maximum width of 100 cm and a fixed length of 80 cm.



FOLDING SIDE EDGES

Aluminum fall prevention side edges to increase safety in certain contexts of use.



REMOVABLE EXTENSION KIT

Removable third piece with wheels, to be integrated to the ramp to extend its length. Suitable for load capacities up to 1,500 kg.

WM ME



WM PC-R

DESCRIPTION:

Loading ramp with non-slip perforated mesh top, suitable for equipment with large rubberized wheels.



FEATURES



Capacity:
500kg



Handling:
External and internal rotation



Custom size:
Width 60 to 137.5 cm,
Length 195 to 325 cm

- Almond-shaped aluminum surface non-skid.
- Wheel for easy opening.
- Self-leveling legs.
- Adjustable band that connects with surfaces.



OPENING AND CLOSING:

Patented dual opening/closing system: horizontal for loading/unloading and vertical to clear the cargo area and access to the van. The spring system balances the weight, making the ramp light and safe to handle independently.

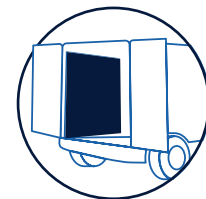
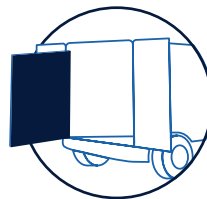
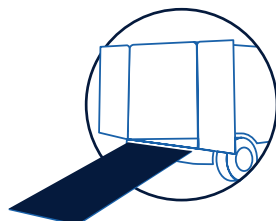
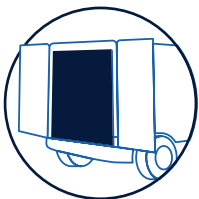

WM PC-R

EXAMPLES OF POSSIBLE CONFIGURATIONS

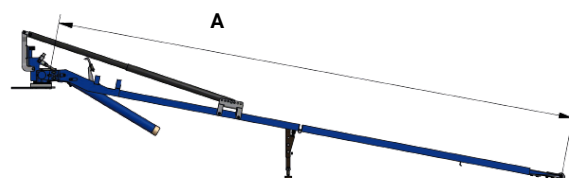
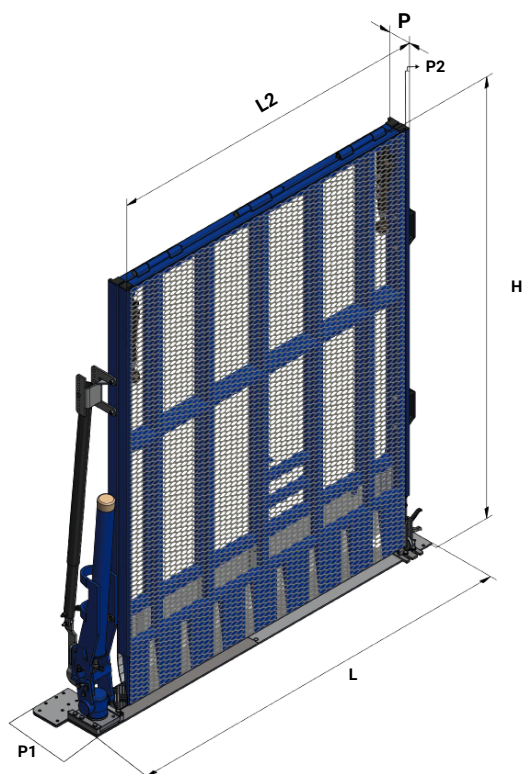

L2 (mm)	A (mm)	L (mm)	H (mm)	P (mm)	P1 (mm)	P2 (mm)	Capac. (Kg)	Peso* (Kg)
900	2200	1165	1215	95	250	8	500	81
950	2500	1215	1365	95	250	8	500	88
1000	3000	1265	1615	95	250	8	500	106
1000	3250	1265	1740	95	250	8	500	124
1050	2700	1315	1515	95	250	8	500	96
1100	3000	1365	1615	95	250	8	500	131
1100	2500	1365	1365	95	250	8	500	106
1200	2700	1465	1465	95	250	8	500	117
1200	3250	1465	1740	95	250	8	500	148
1250	2800	1515	1515	95	250	8	500	128
1250	3000	1515	1615	95	250	8	500	145
1300	3000	1565	1615	95	250	8	500	139
1300	3250	1565	1740	95	250	8	500	159
1350	3200	1615	1715	95	250	8	500	160
1350	3250	1615	1740	95	250	8	500	171

* Il peso non comprende il kit di montaggio, che dipende dal furgone. (min. 2 Kg - max. 7 Kg)

WM PC-R

OPTIONAL



FOLDING SIDE EDGES

Aluminum fall prevention side edges to increase safety in certain contexts of use.



ADDITIONAL KIT - 3RD PIECE

Reduces the angle of inclination for 3-piece folding ramps, ideal for small vehicles. Available for load capacities up to 1,000 kg, with a maximum width of 100 cm and a fixed length of 80 cm.



SPECIAL FEET

In the case of machines that are very low from the ground, special feet are available that create two different inclinations of the plane, favoring its ascent.



WHEEL KIT

Designed to facilitate the opening and closing of the ramp, making it easier to move. It is standard on the right side, available as an option for the left side.

WM PC-R



WM ME-R

DESCRIPTION:

Loading ramp with non-slip surface made of perforated mesh. The most functional solution for loading goods equipped with rubber tires.



FEATURES



Capacity:
500kg



Handling:
Apertura in senso orizzontale



Custom size:
Width 60 to 137.5 cm,
Length 195 to 325 cm

- Almond-shaped aluminum surface non-skid.
- Wheel for easy opening.
- Self-leveling legs.
- Adjustable band that connects with surfaces.

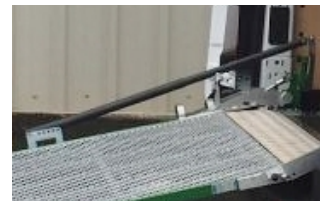

OPENING AND CLOSING:

Patented dual opening/closing system: horizontal for loading/unloading and vertical to clear the cargo area and access to the van. The spring system balances the weight, making the ramp light and safe to handle independently.

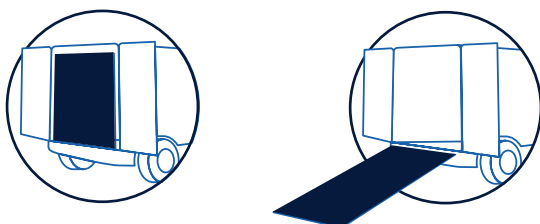

WM ME-R

EXAMPLES OF POSSIBLE CONFIGURATIONS

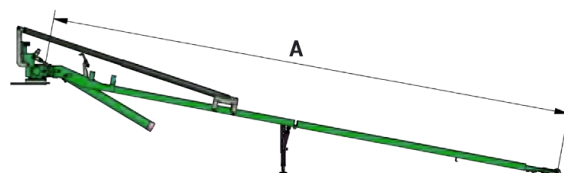
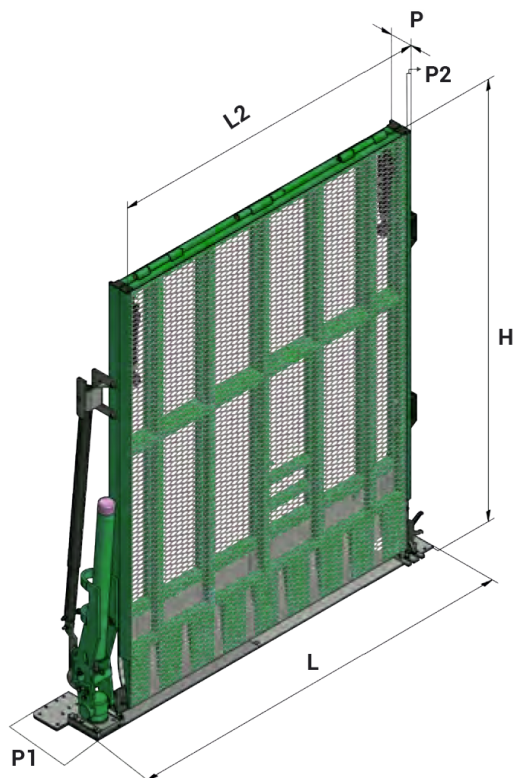

L2 (mm)	A (mm)	L (mm)	H (mm)	P (mm)	P1 (mm)	P2 (mm)	Capac. (Kg)	Peso* (Kg)
900	2200	1165	1215	95	250	8	600	81
950	2500	1215	1365	95	250	8	600	88
1000	3000	1265	1615	95	250	8	1000	106
1000	3250	1265	1740	95	250	8	1500	124
1050	2700	1315	1515	95	250	8	600	96
1100	3000	1365	1615	95	250	8	1500	131
1100	2500	1365	1365	95	250	8	1000	106
1200	2700	1465	1465	95	250	8	1000	117
1200	3250	1465	1740	95	250	8	1500	148
1250	2800	1515	1515	95	250	8	1000	128
1250	3000	1515	1615	95	250	8	1500	145
1300	3000	1565	1615	95	250	8	1000	139
1300	3250	1565	1740	95	250	8	1500	159
1350	3200	1615	1715	95	250	8	1500	160
1350	3250	1615	1740	95	250	8	1800	171

* Il peso non comprende il kit di montaggio, che dipende dal furgone. (min. 2 Kg - max. 7 Kg)

WM ME-R

OPTIONAL



FOLDING SIDE EDGES

Aluminum fall prevention side edges to increase safety in certain contexts of use.

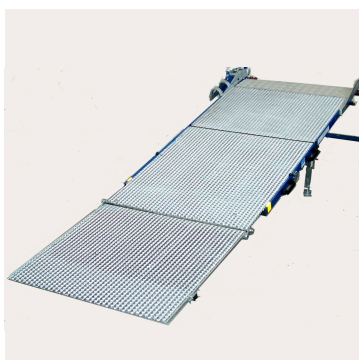

ADDITIONAL KIT - 3RD PIECE

Riduce l'angolo di inclinazione delle rampe pieghevoli a 3 pezzi, ideali per i veicoli di piccole dimensioni. Disponibile per portate fino a 1.000 kg, con una larghezza massima di 100 cm e una lunghezza fissa di 80 cm.



SPECIAL FEET

In the case of machines that are very low from the ground, special feet are available that create two different inclinations of the plane, favoring its ascent.



WHEEL KIT

Designed to facilitate the opening and closing of the ramp, making it easier to move. It is standard on the right side, available as an option for the left side.

WM ME-R

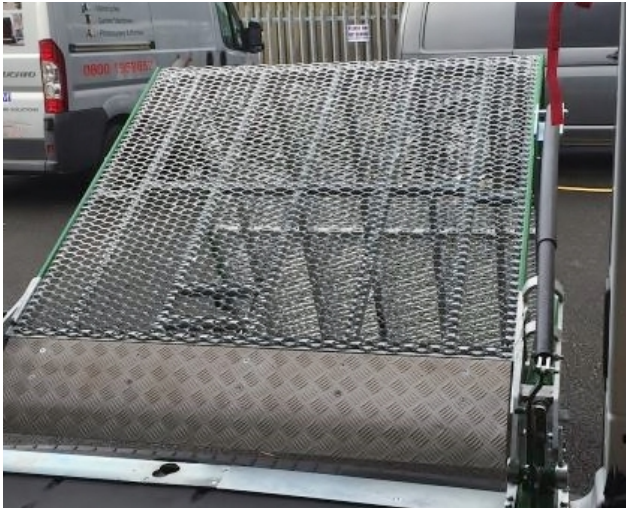

WM LIGHT PLUS

DESCRIPTION:

Lightweight and durable aluminum loading ramp for loads up to 600 kg. Equipped with external rotation for quick access to the compartment.



FEATURES



Capacity:

400 kg and 600 kg



Handling:

External rotation



Custom size:

Width 40 to 120 cm,
Length 175 to 325 cm

- Almond-shaped aluminum surface non-skid.
- Wheel for easy opening.
- Self-leveling legs.
- Adjustable band that connects with surfaces.



OPENING AND CLOSING:

Patented dual opening/closing system: horizontal for loading/unloading and vertical to clear the cargo area and access to the van. The spring system balances the weight, making the ramp light and safe to handle independently.

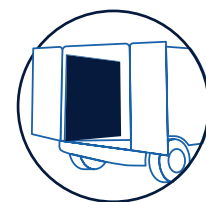
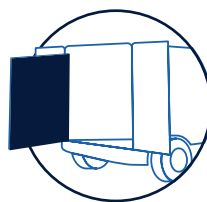
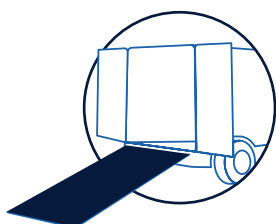
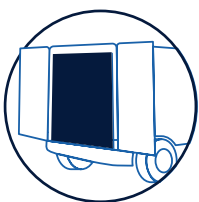

WM LIGHT PLUS

EXAMPLES OF POSSIBLE CONFIGURATIONS

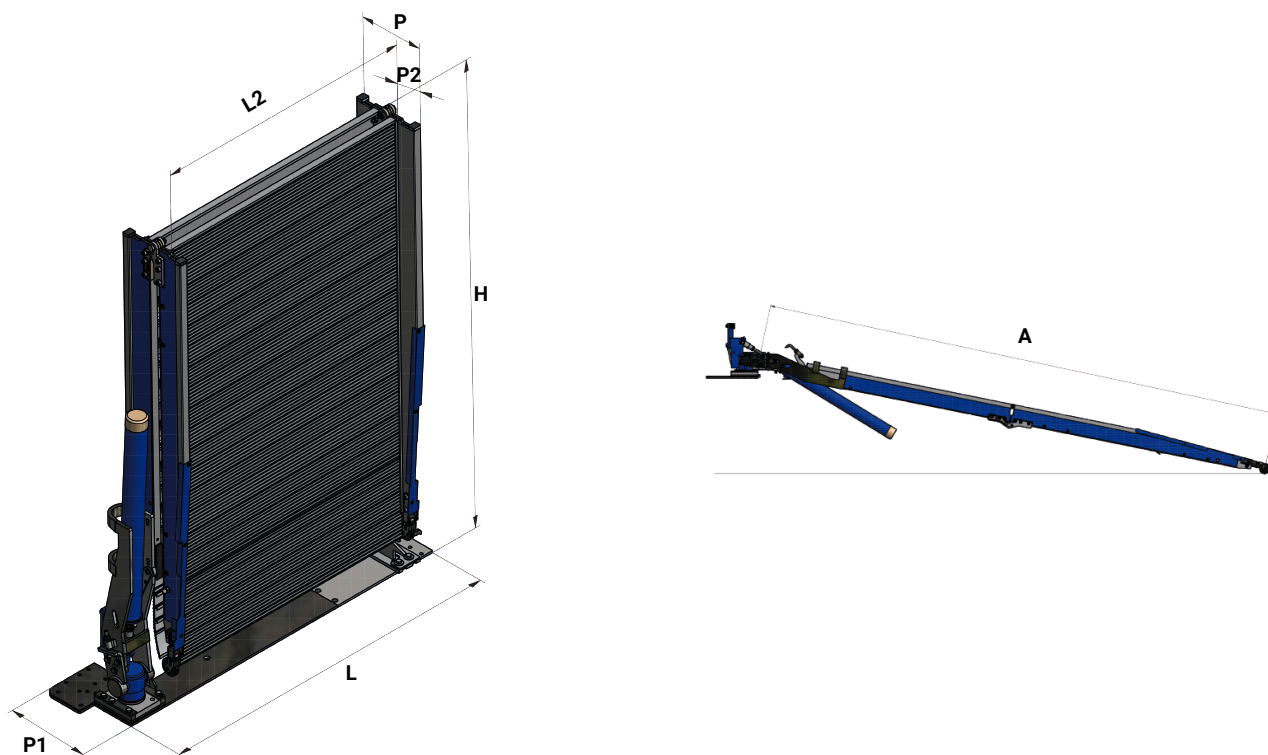

L2 (mm)	A (mm)	L (mm)	H (mm)	P (mm)	P1 (mm)	P2 (mm)	Capac. (Kg)	Peso* (Kg)
800	2200	1065	1175	203	250	60	600	71
900	2500	1165	1300	203	250	60	600	78
900	3000	1165	1425	203	250	60	600	83
950	3250	1215	1175	203	250	60	600	76
950	2700	1215	1550	203	250	60	600	89
1000	3000	1265	1425	203	250	60	400	87
1000	2500	1265	1675	203	250	60	400	96
1000	2700	1265	1800	203	250	60	400	101
1050	3250	1315	1425	203	250	60	400	89
1050	2800	1315	1675	203	250	60	400	98
1100	3000	1365	1550	203	250	60	400	96
1100	3000	1365	1800	203	250	60	400	106
1200	3250	1465	1425	203	250	60	400	95
1200	3200	1465	1675	203	250	60	400	105
1200	3250	1465	1800	203	250	60	400	111

* Il peso non comprende il kit di montaggio, che dipende dal furgone. (min. 2 Kg - max. 7 Kg)

WM LIGHT PLUS

OPTIONAL



INTERNAL ROTATION

Hook can be used to lock the ramp in a fully rotated position inside the vehicle.



ADDITIONAL KIT - 3RD PIECE

Reduces the angle of inclination for 3-piece folding ramps, ideal for small vehicles. Available for load capacities up to 1,000 kg, with a maximum width of 100 cm and a fixed length of 80 cm.

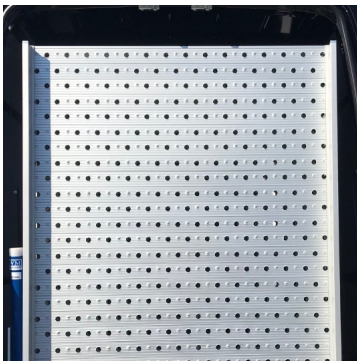

PERFORATED PLANE

It secures the ramp in a fully rotated outward position, preventing gusts of wind from causing it to move and hit people or property.



MOVABLE BAND FOR BRIDGE USE

Removable third piece with wheels, to be integrated to the ramp to extend its length. Suitable for load capacities up to 1,500 kg.

WM LIGHT PLUS



WM LIGHT

DESCRIPTION:

Removable loading ramp. It is the most versatile model in the WM range and is very well suited to light loads of up to 400 kg.



FEATURES



Capacity:
400kg



Handling:
External and internal rotation



Custom size:
Width 40 to 105 cm,
Length 150 to 325 cm

- Almond-shaped aluminum surface non-skid.
- Wheel for easy opening.
- Self-leveling legs.
- Adjustable band that connects with surfaces.



OPENING AND CLOSING:

An external rotation kit that allows the ramp to open vertically, like a second door, is available upon request.

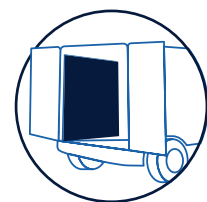
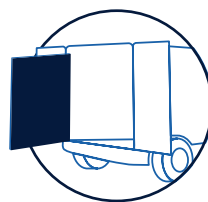
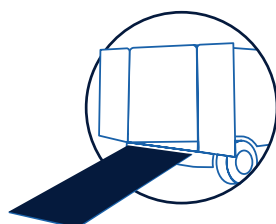
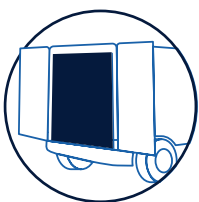

WM LIGHT

EXAMPLES OF POSSIBLE CONFIGURATIONS

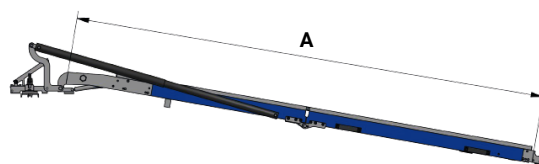
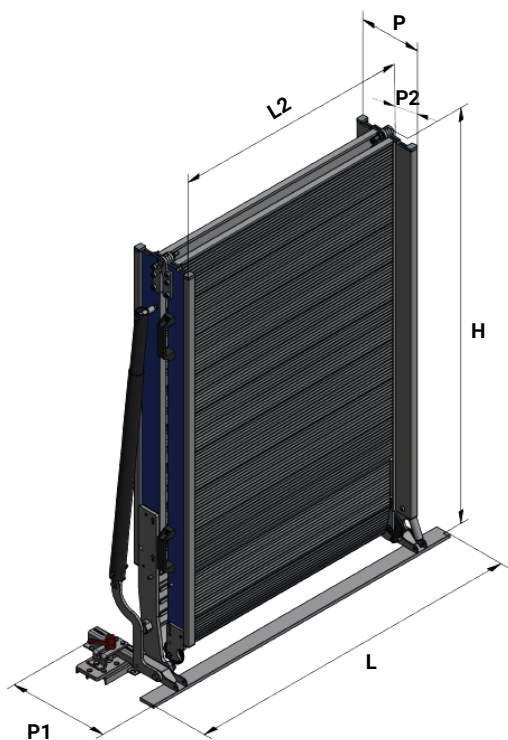

L2 (mm)	A (mm)	L (mm)	H (mm)	P (mm)	P1 (mm)	P2 (mm)	Capac. (Kg)	Peso* (Kg)
600	2000	900	1090	203	345	60	400	46
650	2250	950	1215	203	345	60	400	51
700	2000	100	1090	203	345	60	400	49
750	2500	1050	1340	203	345	60	400	58
800	2750	1100	1465	203	345	60	400	64
800	3000	1100	1590	203	345	60	400	68
800	3250	1100	1715	203	345	60	400	72
850	2500	1150	1340	203	345	60	400	62
850	3250	1150	1715	203	345	60	400	75
900	3000	1200	1590	203	345	60	400	73
950	2750	1250	1465	203	345	60	400	71
1000	2500	1300	1340	203	345	60	400	68
1000	2750	1300	1465	203	345	60	400	73
1000	3000	1300	1590	203	345	60	400	78
1050	3250	1350	1715	203	345	60	400	85

* The indicated weight does not include the 5 kg mounting kit. Optional external rotation weighs + 6 kg

WM LIGHT

OPTIONAL



EXTERNAL ROTATION

Rotation kit that allows the ramp to be rotated outward from the van by 90°. It allows access to the vehicle compartment without using the platform.



BRIDGE USE

Reduces the angle of inclination for 3-piece folding ramps, ideal for small vehicles. Available for load capacities up to 1,000 kg, with a maximum width of 100 cm and a fixed length of 80 cm.

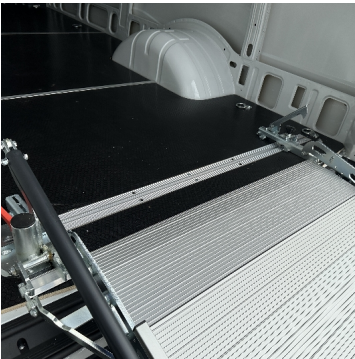

3 TYPES OF MOUNTING

- Fixed assembly
- 2-plate assembly
- Assembly with full bar



PLAN VERSIONS

It is possible to have the ramp with a perforated aluminum surface featuring alternating convex holes, model WM LIGHT-R. The surface is more slip-resistant and the load capacity remains 400kg. Alternatively, you can have a surface in stretched aluminum mesh, referred to as the WM LIGHT-R version, with a load capacity of 300kg.

WM LIGHT



WM LIGHT-R

DESCRIZIONE:

Loading ramp suitable for transporting people. It features a meshed aluminum surface for enhanced rear visibility.



CARATTERISTICHE



Capacity:
300 kg



Handling:
Removable



Custom size:
Width: 80 and 100 cm
Length: from 150 to 325 cm

- Almond-shaped aluminum surface non-skid.
- Wheel for easy opening.
- Self-leveling legs.
- Adjustable band that connects with surfaces.

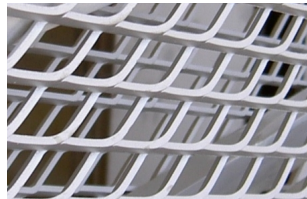

OPENING AND CLOSING:

Upon request, an external rotation kit is available that allows the ramp to open vertically, like a second door. The ramp can be easily removed from the vehicle using the handles located on its sides.

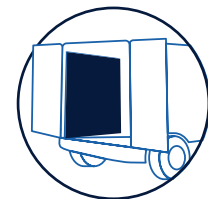
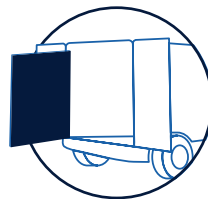
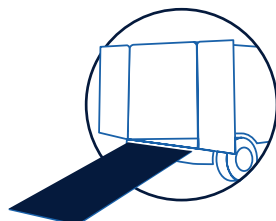
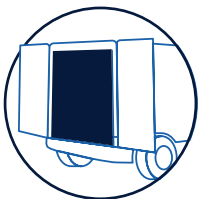

WM LIGHT-R

OPTIONAL



EXTERNAL ROTATION

Rotation kit that allows the ramp to rotate outward by 90°. It enables access to the vehicle compartment without using the platform (e.g. for loading pallets with forklifts).

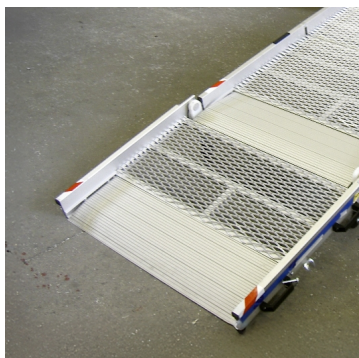

ADDITIONAL THIRD PIECE KIT

Reduces the inclination angle of the ramp, which is foldable in 3 parts. Ideal for small vehicles. Available for loads up to 300 kg.



FIXED ASSEMBLY

On request, a fixed base can be installed on the ramp. This makes the ramp permanently fixed to the vehicle, rather than removable. This solution simplifies and speeds up the installation process, estimated to take 30 minutes.



PIVOT FOR BRIDGE USE

Thanks to a special pivot that locks the ramp's hinges, it can be used as a bridge to connect two surfaces at different heights (vehicle and steps, platforms, etc.).

WM LIGHT-R



WM EASY

DESCRIPTION:

Loading ramp with lateral positioning, agile and simple to use. It always keeps the cargo area clear.



FEATURES



Capacity:
300 kg



Handling:
Lateral positioning



Custom size:
80 cm wide,
Length 200, 225, 250, 275 and 300 cm

- Almond-shaped aluminum surface non-skid.
- Wheel for easy opening.
- Self-leveling legs.
- Adjustable band that connects with surfaces.



OPENING AND CLOSING:

Side-positioned handling, which is agile and easy to use, allows the cargo area to be left clear at all times and minimizes clutter.

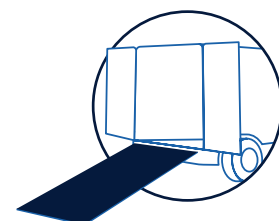
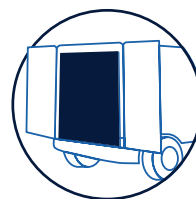
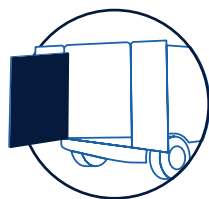
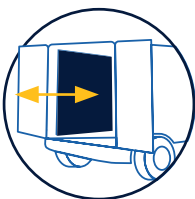

WM EASY

EXAMPLES OF POSSIBLE CONFIGURATIONS

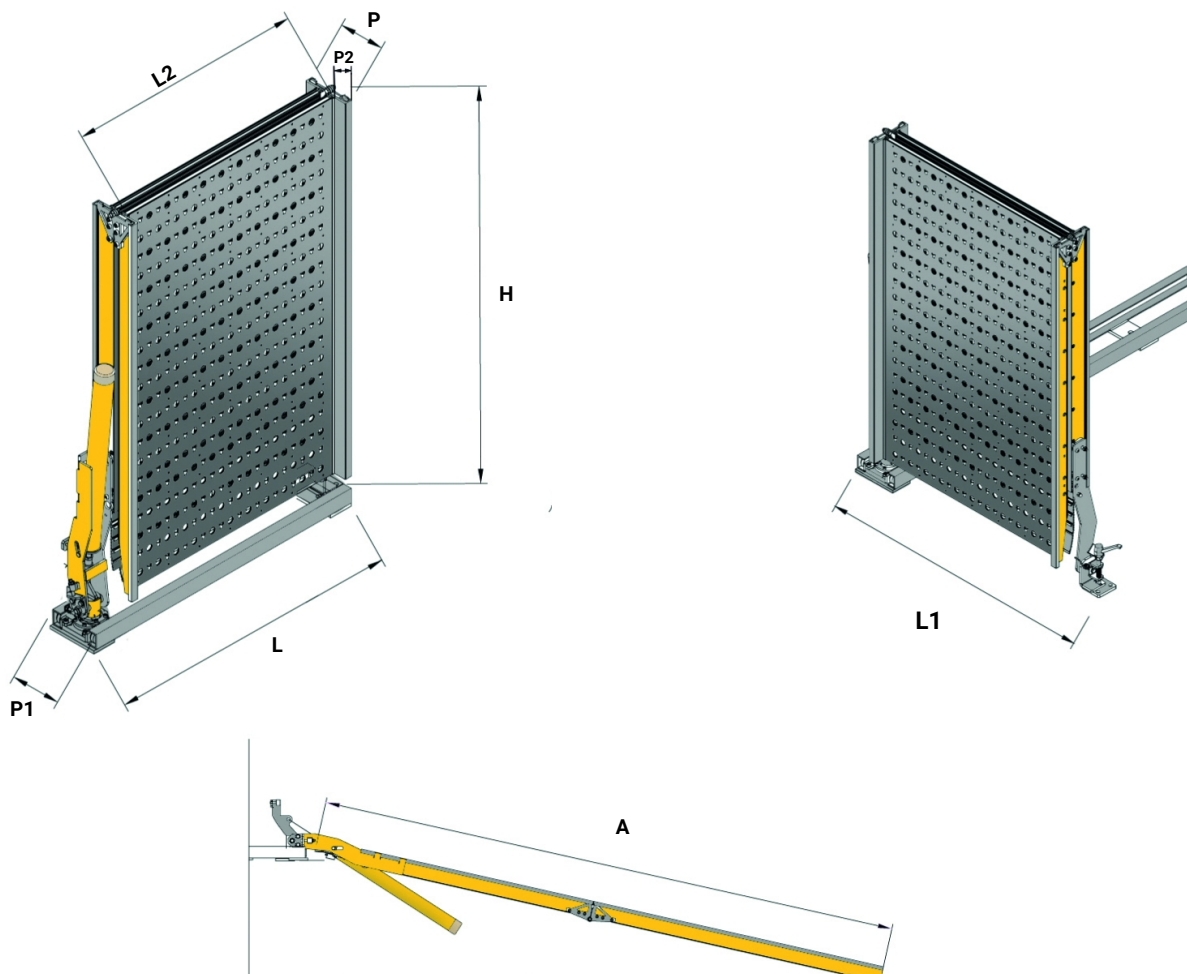

L2 (mm)	L (mm)	L1 (mm)	A (mm)	H (mm)	P (mm)	P1 (mm)	P2 (mm)	Capac. (Kg)	Peso* (Kg)
800	1170	1180	2000	1180	155	250	45	300	64
800	1170	1180	2250	1305	155	250	45	300	67
800	1170	1180	2500	1430	155	250	45	300	70
800	1170	1180	2750	1555	155	250	45	300	73
800	1170	1180	3000	1680	155	250	45	300	75

* The indicated weight includes the assembly kit

WM EASY

OPTIONAL



RIGHT-HAND VERSION

Upon request, it is possible to fix the ramp on the right side of the van by reversing its rotation.

ADVANTAGE



FREE CARGO AREA:

Lateral positioning ensures unobstructed access by eliminating any obstacles on the floor.

WM EASY

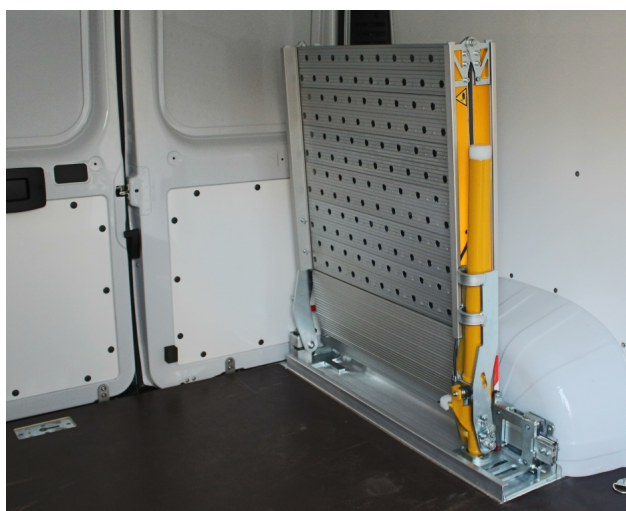

WM READY

DESCRIPTION:

A basic and indispensable model characterized by a fair price and quick assembly.



FEATURES



Capacity:
300 kg



Handling:
Removibile



Custom size:
Width: 80 cm
Length: 200, 225, 250, and 300 cm

- Almond-shaped aluminum surface non-skid.
- Wheel for easy opening.
- Self-leveling legs.
- Adjustable band that connects with surfaces.

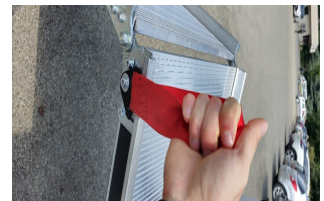

OPENING AND CLOSING:

The ramp can be easily removed from the vehicle using the handles located on its sides. Once removed, the loading area remains completely free. This system also allows the ramp to be transferred from one vehicle to another.

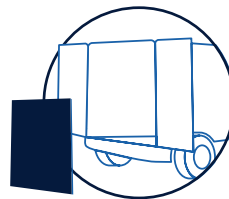
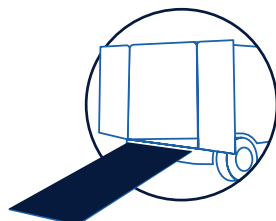
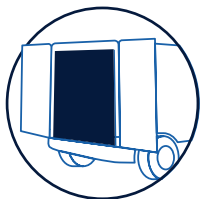

WM READY



EXAMPLES OF POSSIBLE CONFIGURATIONS

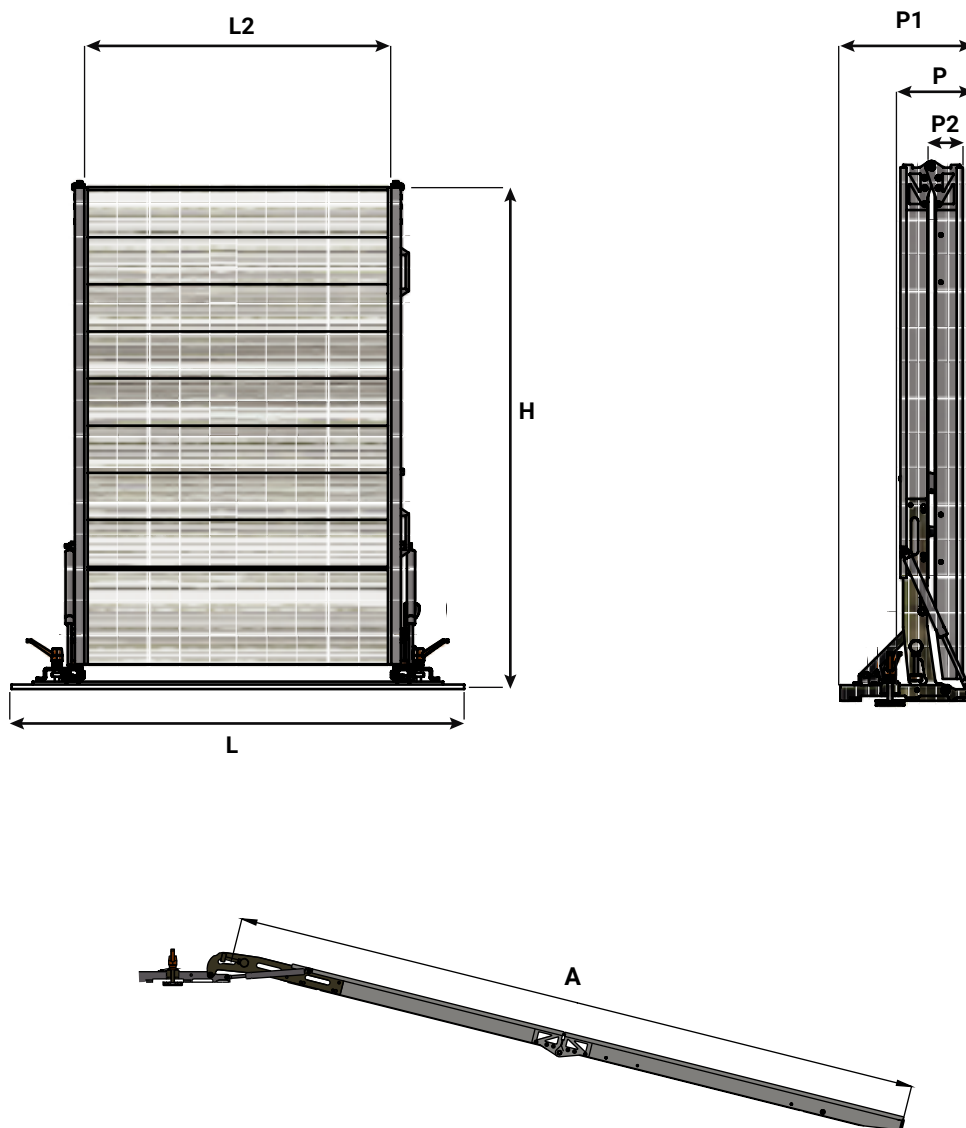

L2 (mm)	L (mm)	A (mm)	H (mm)	P (mm)	P1 (mm)	P2 (mm)	Capac. (Kg)	Peso* (Kg)
800	1090	2250	1215	185	330	45	300	33
800	1090	2500	1340	185	330	45	300	39
800	1090	3000	1590	185	330	45	300	45

* The indicated weight does not include the mounting kit which is, 2 kg.

WM READY

OPTIONAL

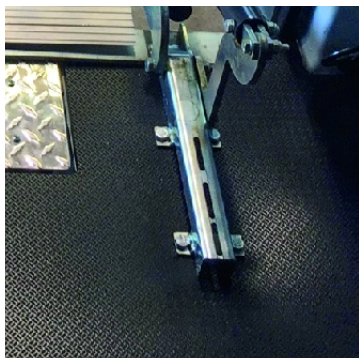

FIXED ASSEMBLY

Upon request, it is possible to install a fixed base on the ramp. This makes the ramp permanently fixed to the vehicle and no longer removable. This solution simplifies and speeds up the installation process, estimated at 30 minutes.

ADVANTAGE



LOCKING HOOK

It ensures safety and ease of use.

WM READY



WM MOBILE

DESCRIPTION:

Mobile loading ramp. It folds into two parts for easy storage in the van and operates simply by resting, without any assembly required.



FEATURES



Capacity:
300 kg per pair



Handling:
Mobile



Custom size:
Width from 30 to 100 cm
Length from 150 to 325 cm

- Almond-shaped aluminum surface non-skid.
- Wheel for easy opening.
- Self-leveling legs.
- Adjustable band that connects with surfaces.



OPENING AND CLOSING:

Mobile ramp with no assembly—it rests directly on the van. Its special adjustable support system provides 4 positions to best adapt to different van heights.

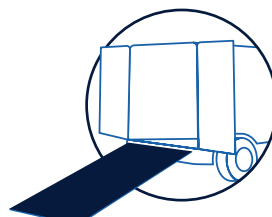
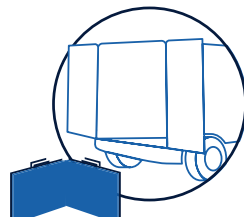
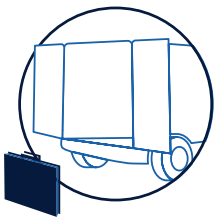

WM MOBILE



EXAMPLES OF POSSIBLE CONFIGURATIONS

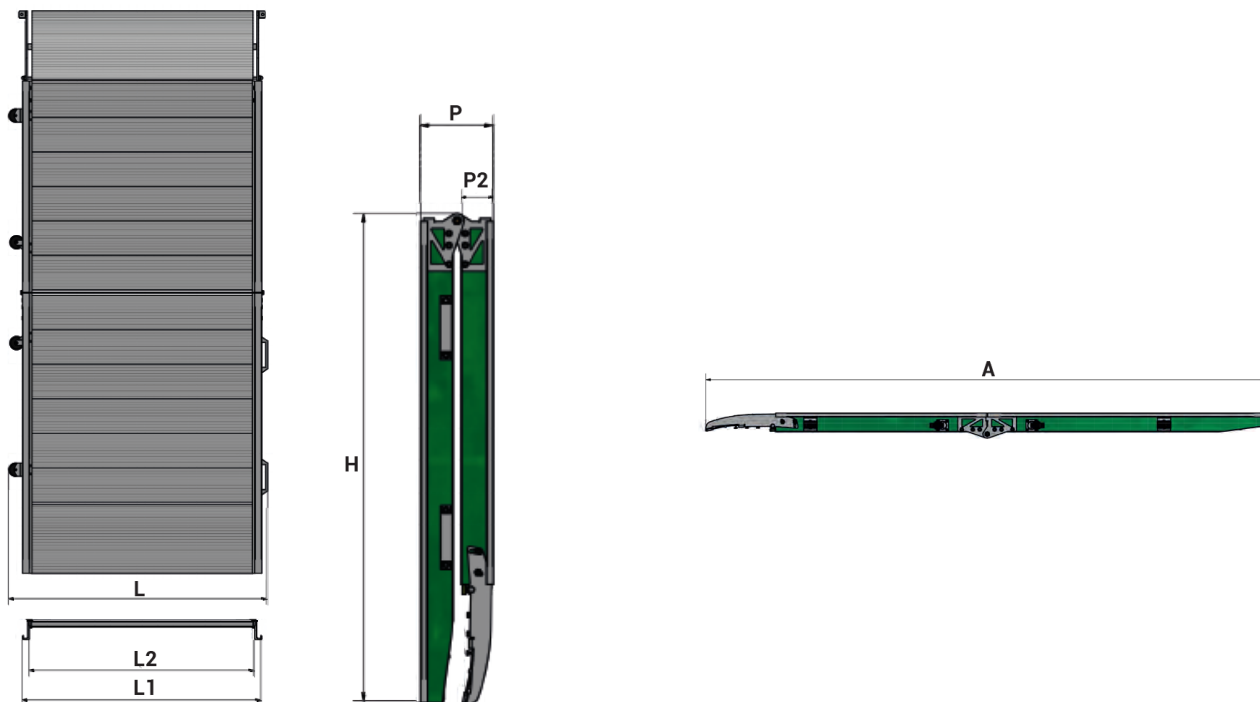

L2 (mm)	A (mm)	L1 (mm)	L (mm)	H (mm)	P (mm)	P2 (mm)	Capac. (Kg)	Peso* (Kg)
400	1750	465	905	155	155	45	300	20,5
500	2250	565	1155	155	155	45	300	28,5
600	2500	665	1280	95	155	45	300	34,5
650	2750	736	1405	95	155	45	300	39,5
700	3000	786	1530	95	155	45	300	44,5
700	2000	836	1030	95	155	45	300	31,5
750	2500	836	1280	95	155	45	300	39,5
800	2000	886	1030	95	155	45	300	*27,5
800	2500	936	1280	95	155	45	300	*32,5
800	3000	936	1530	95	155	45	300	*38,5
800	3250	936	1655	95	155	45	300	52,5
850	2000	986	1030	95	155	45	300	36,5
900	3000	1036	1530	95	155	45	300	53,5
1000	2500	1136	1280	95	155	45	300	48,5
1000	3000	1136	1530	95	155	45	300	57,5

* lightened version

WM MOBILE

OPTIONAL

ANODIZED SURFACE

For greater long-term durability and a more aesthetically pleasing appearance, an anodization treatment can be applied to the aluminum.



SINGLE-PIECE RAMP

To have a non-folding, single-piece ramp, it is possible to lock the central hinges of the ramp.

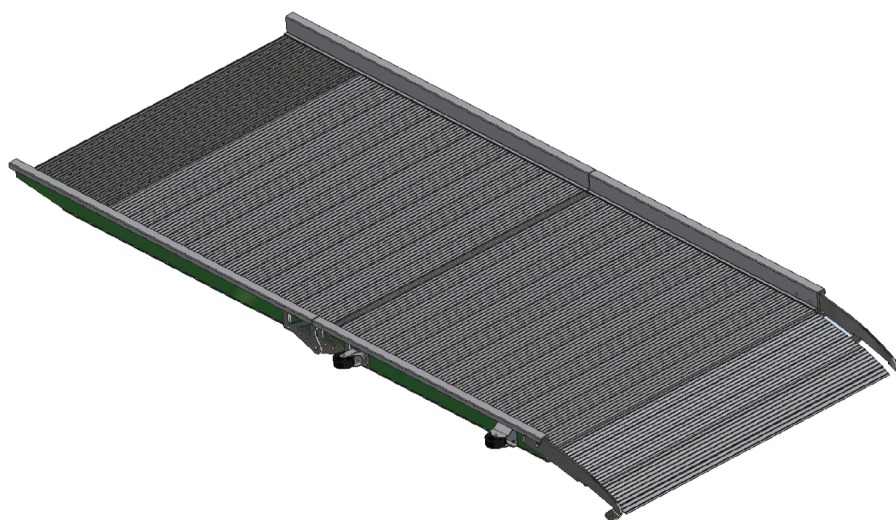

WM MOBILE



WM TELESCOPIC

DESCRIPTION:

Loading ramp suitable for loads up to 1800 kg for light commercial vehicles. Over 500 sizes available.



FEATURES



Capacity:
300 kg per pair



Handling:
Mobile



Custom size:
Width: 18.5 cm
Length: 150, 200, 225, 250, 300 cm

- Almond-shaped aluminum surface non-skid.
- Wheel for easy opening.
- Self-leveling legs.
- Adjustable band that connects with surfaces.



OPENING AND CLOSING:

Dual patented opening/closing system: horizontal for loading/unloading and vertical to clear the cargo area and access to the van. The spring mechanism balances the weight, making the ramp light and safe to handle independently.

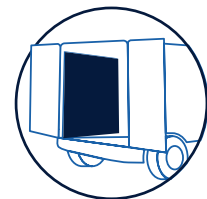
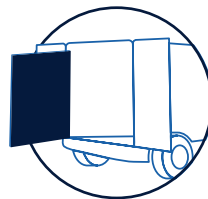
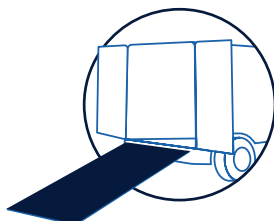
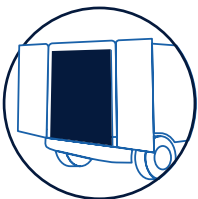

WM TELESCOPIC

EXAMPLES OF POSSIBLE CONFIGURATIONS

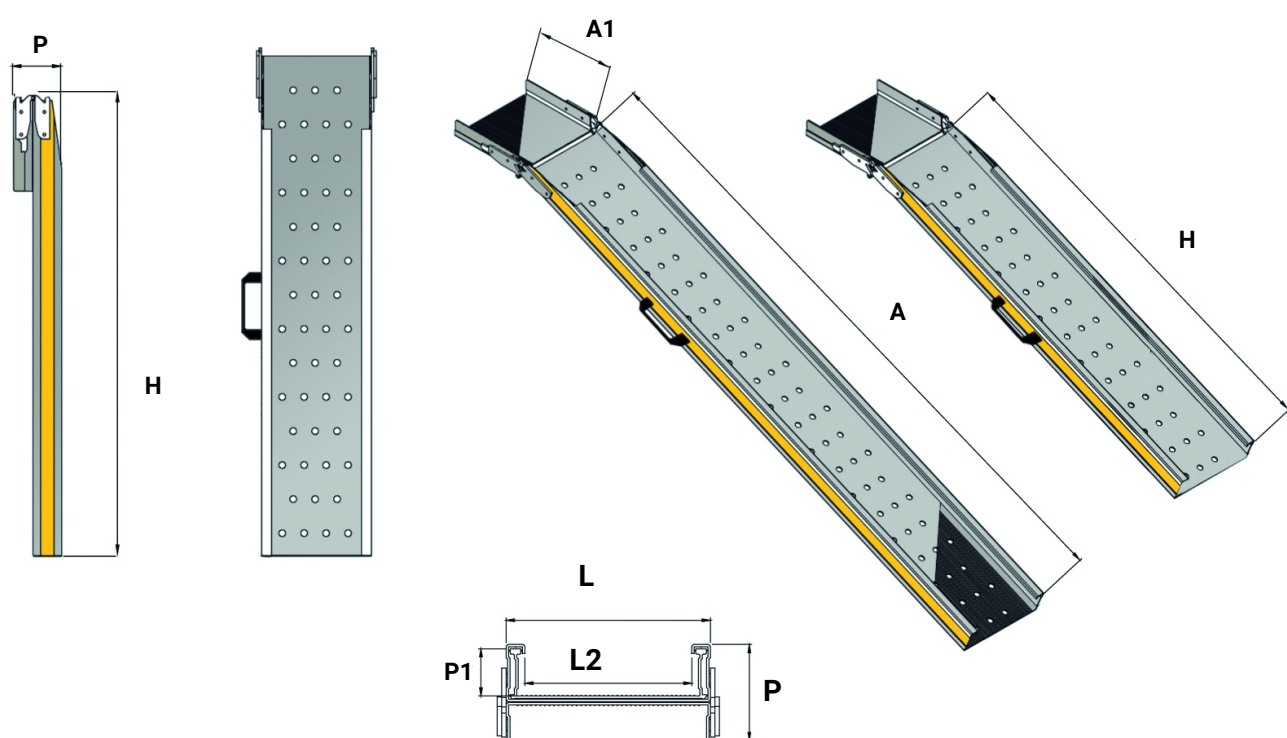

L2 (mm)	A1 (mm)	L (mm)	A (mm)	H (mm)	P (mm)	P1 (mm)	Capac. A coppia (Kg)	Peso (Kg)
185	200	225	1500	900	106	55	300	5
185	200	225	2000	1150	106	55	300	6
185	200	225	2250	1275	106	55	300	6,5
185	200	225	2500	1400	106	55	300	7
185	200	225	3000	1650	106	55	300	8

WM TELESCOPIC

OPTIONAL

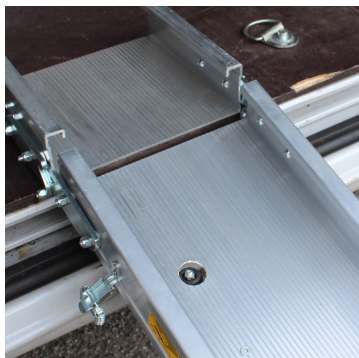

ECO VERSION

ECO version is available: loading surface without holes, without chamfer in the band and without yellow coloring on the side edges.

ADVANTAGE

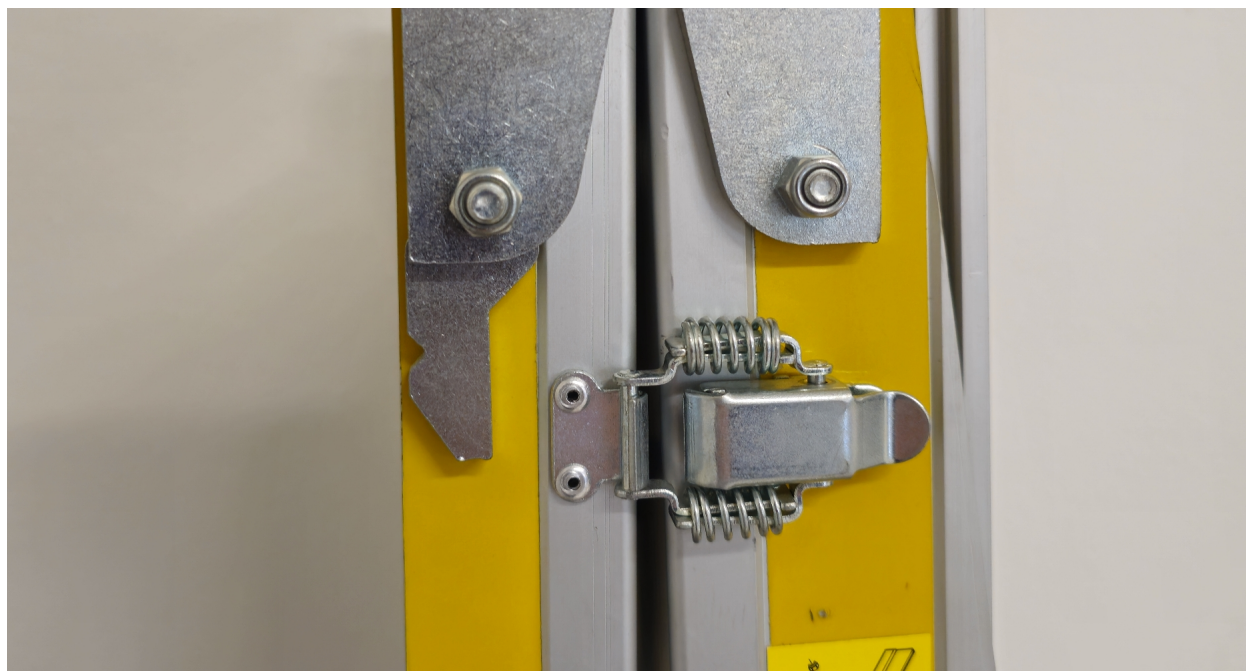

LOCKING HOOK:

It ensures safety and ease of use.

WM TELESCOPIC

