

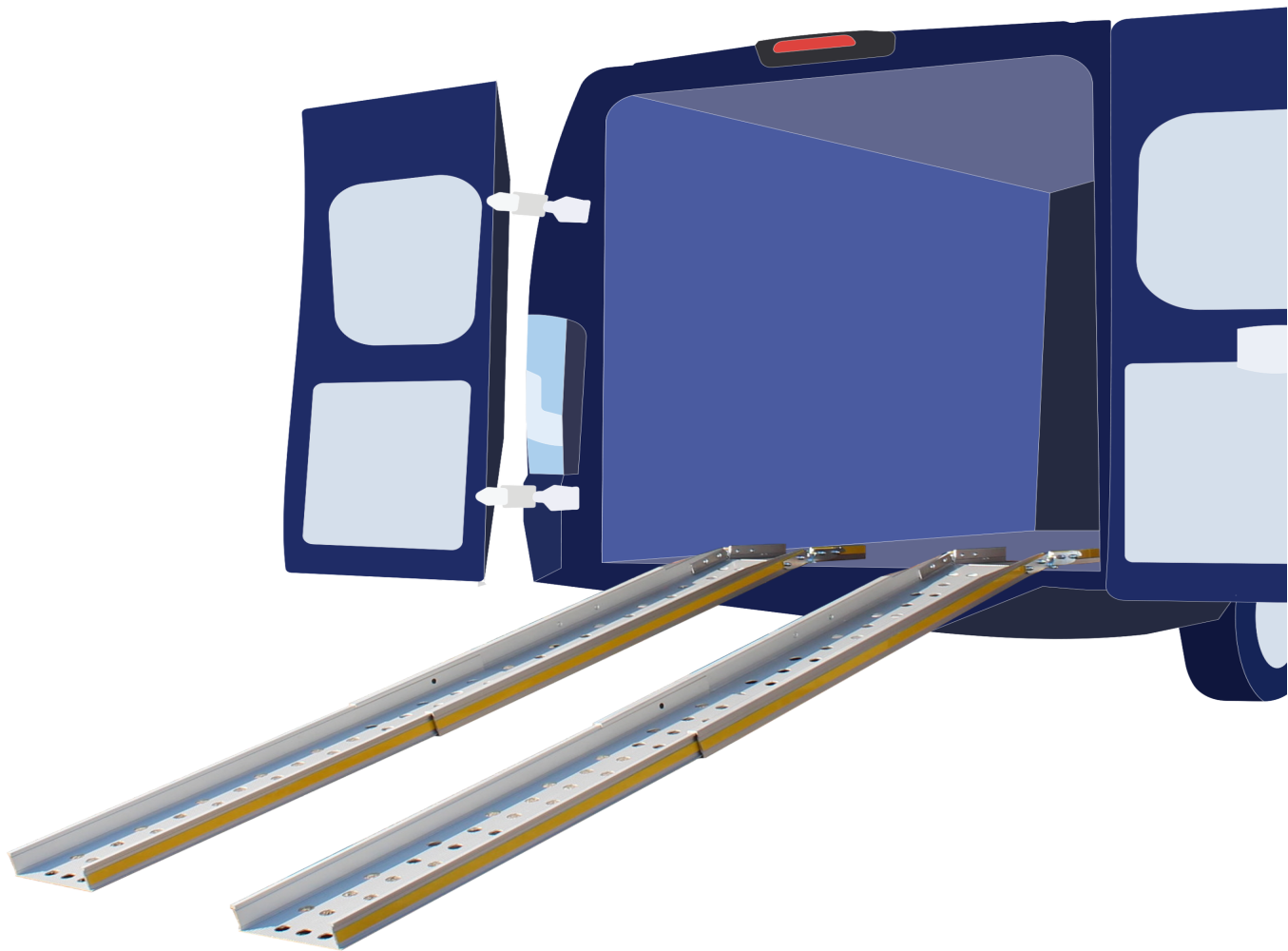

# LOADING RAMPS

Tailored loading and unloading solutions



# Our Loading Ramps

Our ramps are designed to adapt to the loading and unloading operations, meeting the needs of your vehicle and your industry.



## 11 UNIQUE RAMP MODELS

Made of high-quality aluminum and designed in Italy, our loading ramps offer modular and customizable solutions designed to ensure safety, durability and optimal performance.

# OUR RAMPS

---

## ALL RAMPS HAVE



All of our ramps  
are TÜV certified



Approval  
not required



100%  
Made in Italy



2 years of  
warranty

---

## WHY CHOOSE OUR RAMPS

### **Flexibility:**

A complete range of manual ramps for every sector and need;

### **Time saving:**

The operator can upload and unload independently;

### **Quality:**

Guaranteed by in-house production processes (welding and CNC machining) that ensure robustness and durability;

### **Safety:**

Ramps improve working conditions reduce operational risks;

---

**WITH MORE THAN 100 RESELLERS WORLDWIDE,  
OUR SOLUTIONS ARE WHEREVER YOU NEED THEM.**

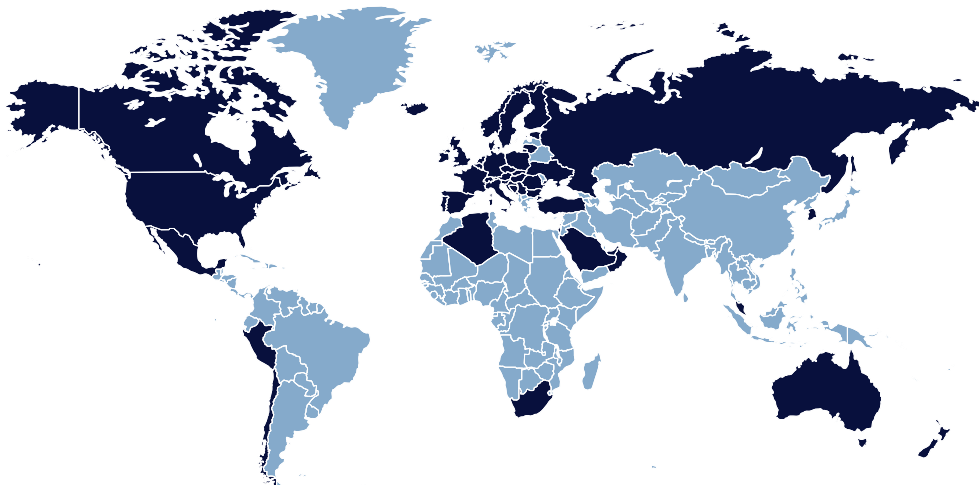

# WM TELESCOPIC

## DESCRIPTION:

Loading ramp suitable for loads up to 1800 kg for light commercial vehicles. Over 500 sizes available.



## FEATURES



**Capacity:**  
300 kg per pair



**Handling:**  
Mobile



**Custom size:**  
Width: 18,5 cm  
Length: 150, 200, 225, 250, 300 cm

- Almond-shaped aluminum surface non-skid.
- Wheel for easy opening.
- Self-leveling legs.
- Adjustable band that connects with surfaces.



## OPENING AND CLOSING:

Dual patented opening/closing system: horizontal for loading/unloading and vertical to clear the cargo area and access to the van. The spring mechanism balances the weight, making the ramp light and safe to handle independently.

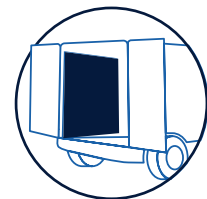
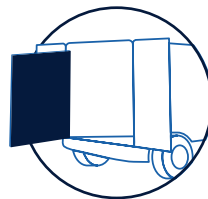
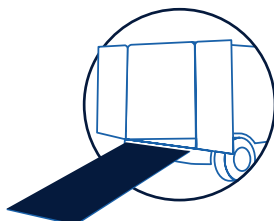
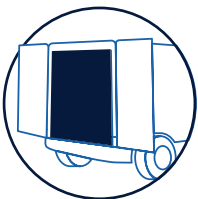

# WM TELESCOPIC

## EXAMPLES OF POSSIBLE CONFIGURATIONS

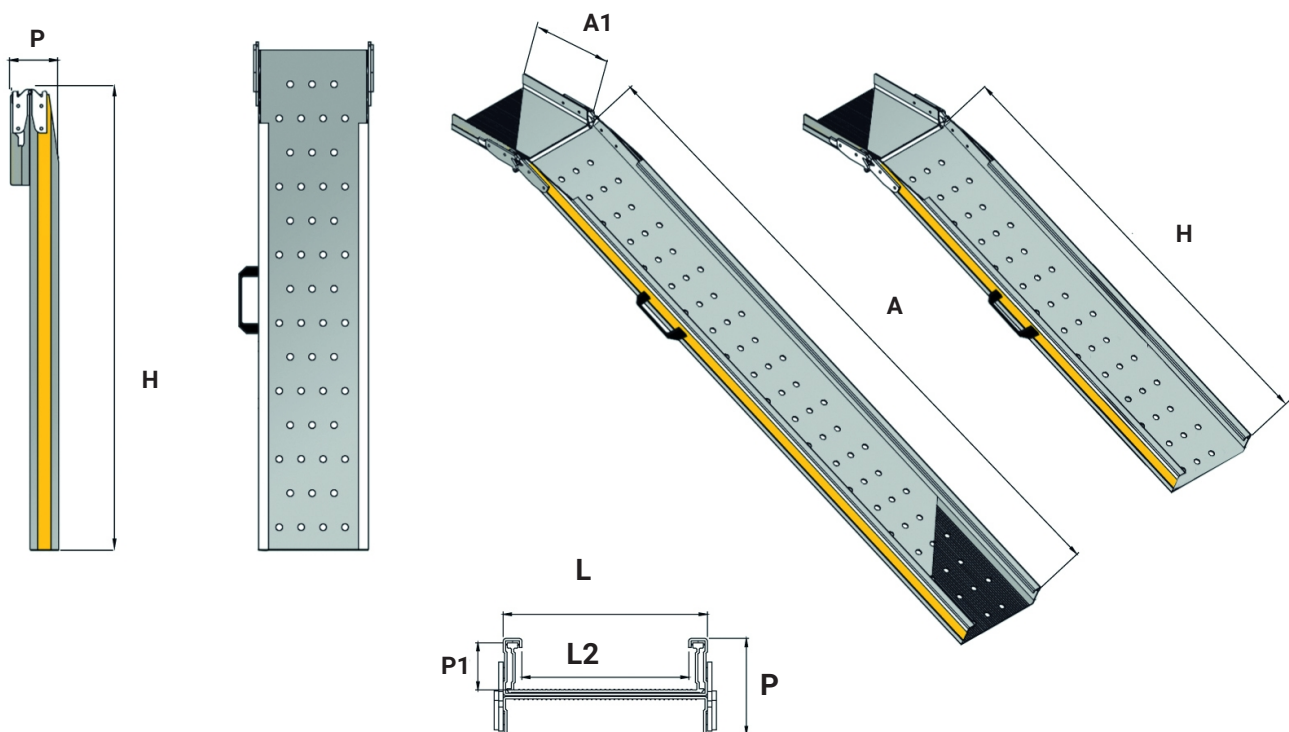

L2 (mm)	A1 (mm)	L (mm)	A (mm)	H (mm)	P (mm)	P1 (mm)	Paarweise Kapazität (Kg)	Weight* (Kg)
185	200	225	1500	900	106	55	300	5
185	200	225	2000	1150	106	55	300	6
185	200	225	2250	1275	106	55	300	6,5
185	200	225	2500	1400	106	55	300	7
185	200	225	3000	1650	106	55	300	8

\* Das Gewicht beinhaltet nicht den Montagesatz, der vom Lieferwagen abhängt. (min. 2 kg - max. 7 kg)

# WM TELESCOPIC

---

## OPTIONAL

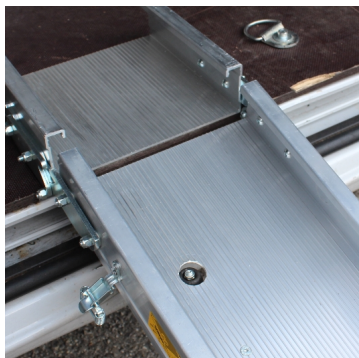

## ECO VERSION

ECO version is available: loading surface without holes, without chamfer in the band and without yellow coloring on the side edges.

## ADVANTAGE

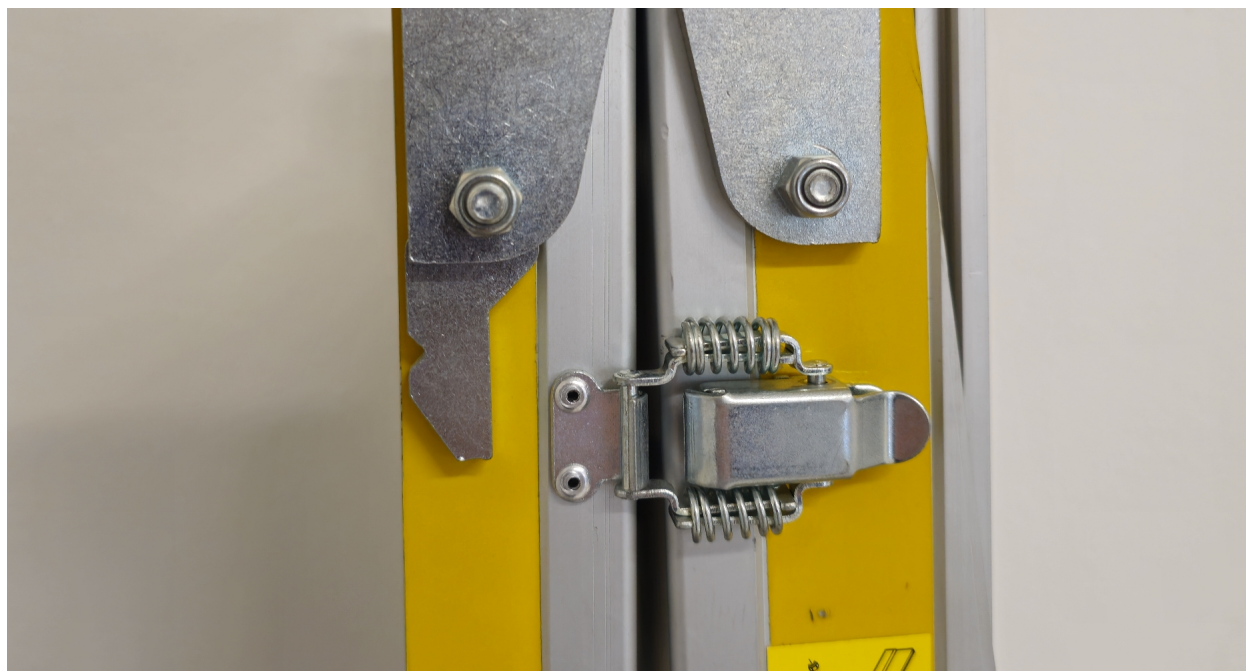

## LOCKING HOOK:

It ensures safety and ease of use.

# WM TELESCOPIC

