

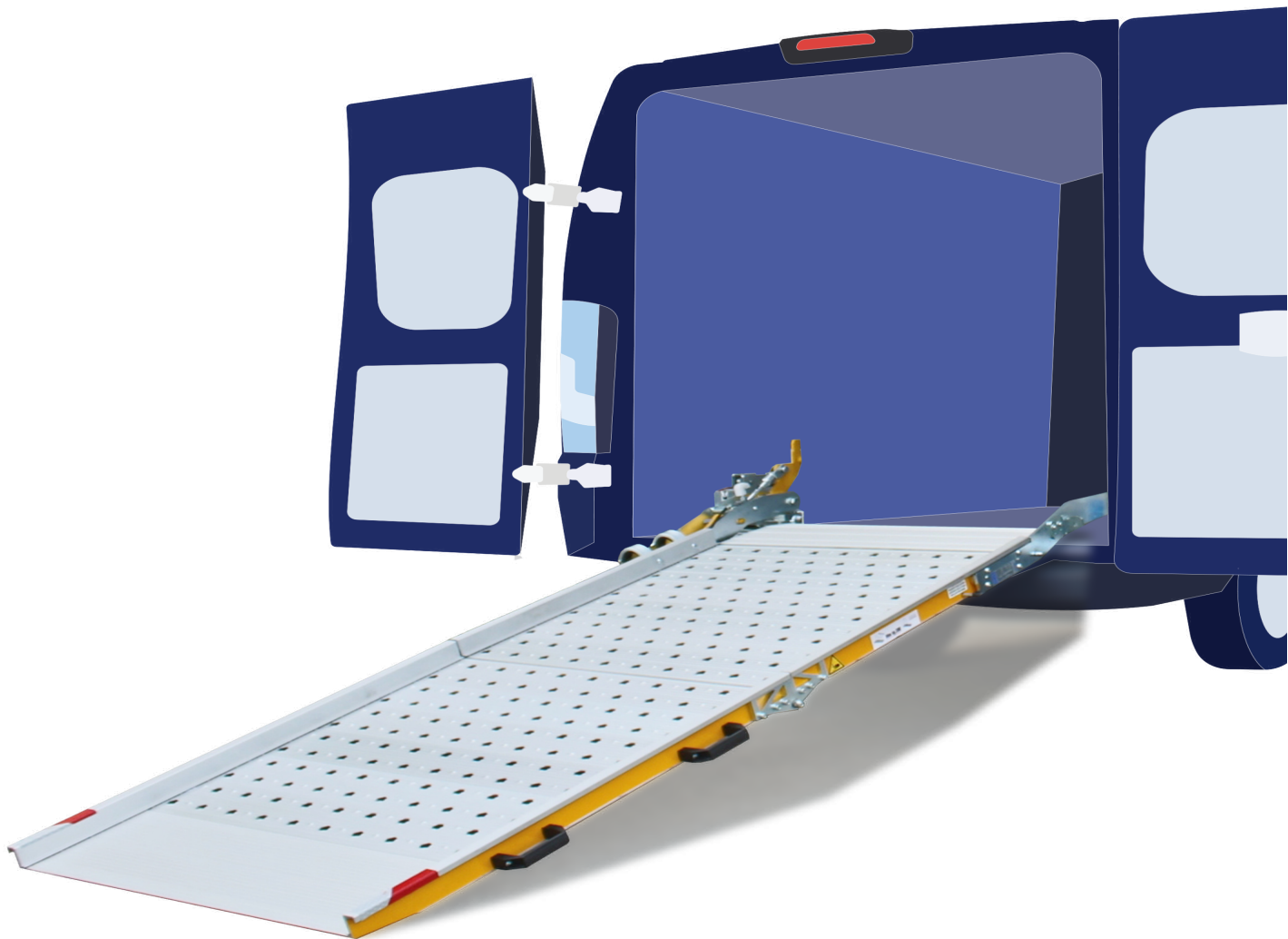

# LOADING RAMPS

Tailored loading and unloading solutions



# Our Loading Ramps

Our ramps are designed to adapt to the loading and unloading operations, meeting the needs of your vehicle and your industry.



## 11 UNIQUE RAMP MODELS

Made of high-quality aluminum and designed in Italy, our loading ramps offer modular and customizable solutions designed to ensure safety, durability and optimal performance.

# OUR RAMPS

---

## ALL RAMPS HAVE



All of our ramps  
are TÜV certified



Approval  
not required



100%  
Made in Italy



2 years of  
warranty

---

## WHY CHOOSE OUR RAMPS

### **Flexibility:**

A complete range of manual ramps for every sector and need;

### **Time saving:**

The operator can upload and unload independently;

### **Quality:**

Guaranteed by in-house production processes (welding and CNC machining) that ensure robustness and durability;

### **Safety:**

Ramps improve working conditions reduce operational risks;

---

**WITH MORE THAN 100 RESELLERS WORLDWIDE,  
OUR SOLUTIONS ARE WHEREVER YOU NEED THEM.**

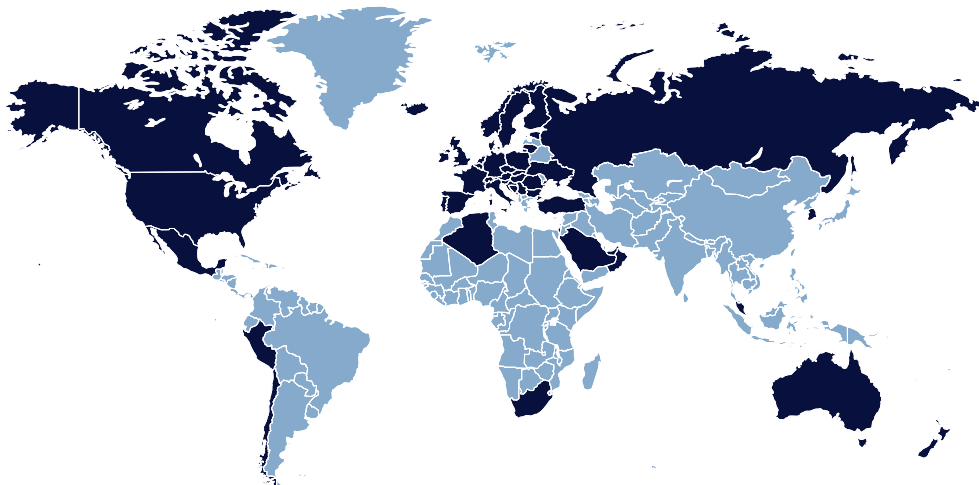

# WM EASY

## DESCRIPTION:

Loading ramp with lateral positioning, agile and simple to use. It always keeps the cargo area clear.



## FEATURES



**Capacity:**  
300 kg



**Handling:**  
Lateral positioning



**Custom size:**  
80 cm wide,  
Length 200, 225, 250, 275 and 300 cm

- Almond-shaped aluminum surface non-skid.
- Wheel for easy opening.
- Self-leveling legs.
- Adjustable band that connects with surfaces.



## OPENING AND CLOSING:

Side-positioned handling, which is agile and easy to use, allows the cargo area to be left clear at all times and minimizes clutter.

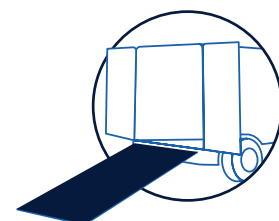
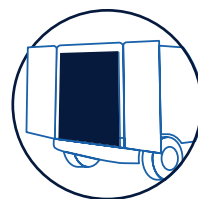
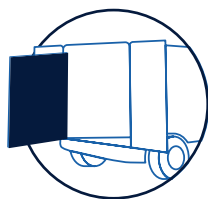
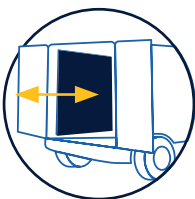

# WM EASY

## EXAMPLES OF POSSIBLE CONFIGURATIONS

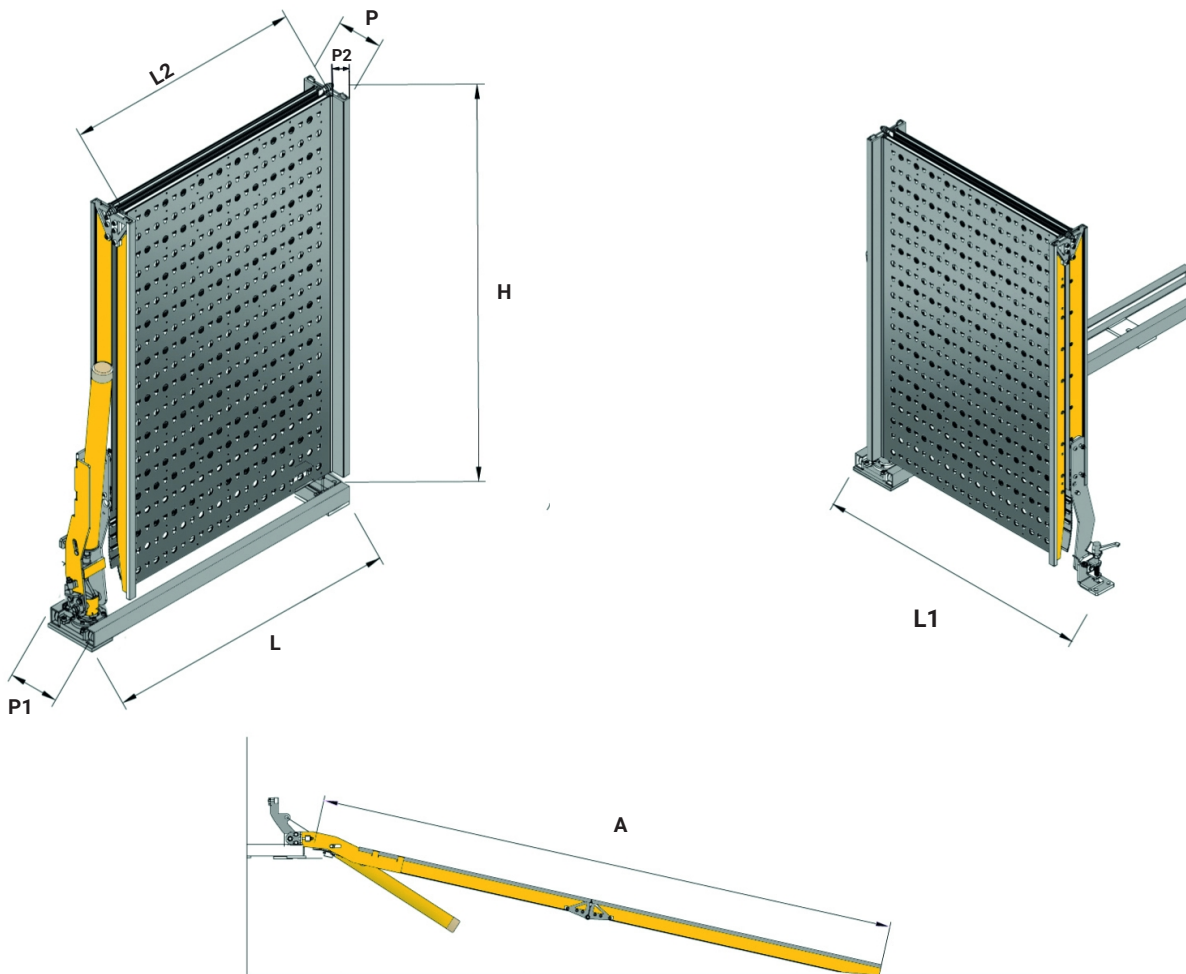

L2 (mm)	L (mm)	L1 (mm)	A (mm)	H (mm)	P (mm)	P1 (mm)	P2 (mm)	Capacity (Kg)	Weight* (Kg)
800	1170	1180	2000	1180	155	250	45	300	64
800	1170	1180	2250	1305	155	250	45	300	67
800	1170	1180	2500	1430	155	250	45	300	70
800	1170	1180	2750	1555	155	250	45	300	73
800	1170	1180	3000	1680	155	250	45	300	75

\* The indicated weight includes the assembly kit

# WM EASY

---

## OPTIONAL



## RIGHT-HAND VERSION

Upon request, it is possible to fix the ramp on the right side of the van by reversing its rotation.

## ADVANTAGE



## FREE CARGO AREA:

Lateral positioning ensures unobstructed access by eliminating any obstacles on the floor.

# WM EASY

